

# 402 WG

Non-return axial guided valve  
02 System

## Technical Data Sheet



## Description

A non-return valve is compatible with many types of fluids and can be adapted to a wide range of installations. However, each of these installations comes with their own particular constraints : mechanical, hydraulic, physical or chemical. The O2 system offers the best compromise between hydraulic performance, ruggedness, sealing-tightness and cost effectiveness with any kind of liquids (subject to a validation of our recommendation service).

Our valves meet the requirements of the Pressure Equipment Directive 2014/68/UE. This range extends from 40 to 500 mm.

- **Internal and external Epoxy coating** of 250µm minimum increasing resistance to corrosion
- **Hydraulic shape** means very little energy loss
- Excellent sealingtightness ensured by **an EPDM seal**
- **Bronze guide ring** enables a better movement of the closing system and preventing premature wear
- **Stainless steel spring** allowing system to function in any position
- **Bosses drilled** on request for by-pass, control or evacuation
- **Passage for cables** of submersible pumps

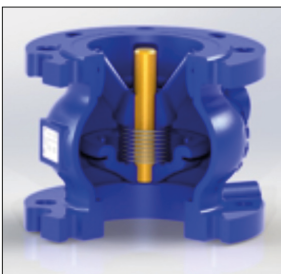

### 402 WG

Axial guided non-return valve - O2 System



DN in mm	PN	PFA in bar	PS in bar				Cat.	Ref.	Weight Kg
			L1	L2	G1	G2			
40	10/16	16	16	16	16	16	I	149B2281IE	4,2
50	10/16	16	16	16	16	16	I	149B2282IE	5,8
65	10/16	16	16	16	15	16	I	149B2283IE	8,1
80	10/16	16	16	16	12	16	I	149B2284IE	10,2
100	10/16	16	16	16	10	16	I	149B2285IE	14,5
125	10/16	16	16	16	0,5	16	I	149B2226IE	24
150	10/16	16	13	16	0,5	16	I	149B2227IE	32
200	10	10	10	10	10	10	II	149B2229IE	53
250	10	10	10	10	10	10	II	149B2230IE	94
300	10	10	10	10	10	10	II	149B2231IE	140
350	10	10	10	10	0,5	10	II	149B2232IE	225
400	10	10	10	10	0,5	10	II	149B2233IE	312
500	10	10	10	10	0,5	10	II	149B2235IE	540

**Important notice:**

The indicated pressure for the different categories of fluids (L1/L2/G1/G2) is under no condition a guarantee of use. Therefore, it is essential to validate the use of products under given operating conditions. The operating instructions are available on our web site [www.socla.com](http://www.socla.com) or by requesting from our sales department.

#### Technical features

Operating temperature	-10°C to 100°C
Permissible operating pressure (PFA) in water	See table above
Maximum permissible pressure (PS) other mediums	See table above
Connection	Flanges drilled PN (see table)
Mediums	Clear liquids, gas

#### Nomenclature and materials

N°	Description	Materials	EURO	ANSI		
1	Casing	DN 40-400	Cast iron/Epoxy	EN 1561 EN-GJL-250	ASTM A 48 35 B	
		DN 500	Cast iron/Epoxy	EN 1563 EN-GJS-400-15	ASTM A 536 65-45-12	
2	O-ring seal	DN 40-250	EPDM			
3	Ring		Bronze	EN 1982 CuSn12-C GS		
4	Guide	DN 50	Bronze	EN 1982 CuSn5Zn5Pb2-C GS		
		DN 40 & 60-400	Cast iron/Epoxy	EN 1561 EN-GJL-250	ASTM A 48 35 B	
		DN 500	Cast iron/Epoxy	EN 1563 EN-GJS-400-15	ASTM A 536 65-45-12	
5	Spring		Stainless steel	EN 10270-3 X10CrNi18-8	AISI 302	
6	Seal		EPDM			
7-8	Closing system	DN 40	Brass	EN 12164 CuZn40Pb2 R360 mini		
		DN 50-65	Bronze	EN 1982 CuSn5Zn5Pb2-C GS		
		DN 80-400	Stem	Bronze	EN 1982 CuSn5Zn5Pb2-C GS	
			Check-valve	Cast iron/Epoxy	EN 1561 EN-GJL-250	ASTM A 48 35 B
		DN 500	Stem	Bronze	EN 1982 CuSn12-C GS	
	Check-valve	Cast iron/Epoxy	EN 1563 EN-GJS-400-15	ASTM A 536 65-45-12		

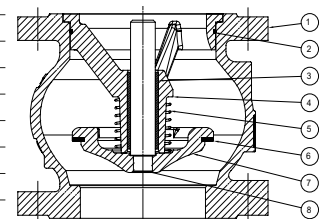

## Approvals

This new non-return valve meets technical prescriptions requirements of the Belgian water market intended for human consumption:

- TV/034/1-B and TV/092/2-B
- TV/031/1-A (SVW) and TV/041/1-A (SVW) of AquaFlanders (Flanders and Wallonia water company)

**ACS** **kiwa**



**Construction standards:**

CE Conformity Directive 2014/68/UE  
Flange drilling according to EN1092-2

**Approval:**

Water companies

## Application

The non-return valve 402 WG SOCLA is the most universal for water supply, pumps protection, general circuits, boosters and water distribution. It can be installed in any position with clear liquids.

## Installation

**Installation :**

Before putting valve into operation, check that:

- the working conditions are compatible with the details given on the identification plate, the instruction notice and the manufacturer's detail,
- the valve works effectively when tried (carry out a few opening and closing operations of the closing system),
- the valve is free-pollution inside.

On a new installation or after maintenance, the circuit must be rinsed with the valve completely open in order to remove solid matter which may damage the internal parts of the valve.

**Commissioning :**

The installation should be put under pressure progressively to avoid damage which might occur to internal components.

Make sure that when flow stops the valve maintains pressure well and that there is no water-hammer which might damage the valve or installation. If there is water-hammer, an anti-water hammer system must be added to the installation.

During a prolonged stoppage, a change in the state of the fluid may result in damage when the installation is brought back into service (solidification...). Establish an adequate procedure program for cleaning the system.

## Maintenance

**Removing:**

1. Remove guide assembly (N°2)
2. Remove the o-ring seal (N°5) from its groove
3. Remove the spring (N°4)
4. Remove all the closing system (N°3)

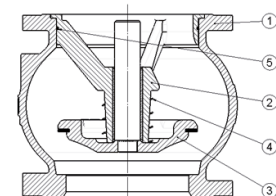

**Reassembly:**

Make sure that the seal is in a good condition before reassembly the valve.

Clean and lubricate it if necessary with a suitable product.

1. Put all the closing system (N°3) into the casing (N°1)
2. Insert the spring (N°4)
3. Put the o-ring seal (N°5) in its groove
4. Insert the guide assembly (N°2). This step may require to use a press.

Once the reassembly done, test the device in order to check its sealing.

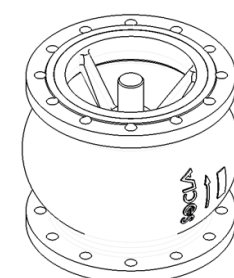

# Operation

## Direction for use:

- Solid line : Valve completely open
- Dotted line : opening stage of valve

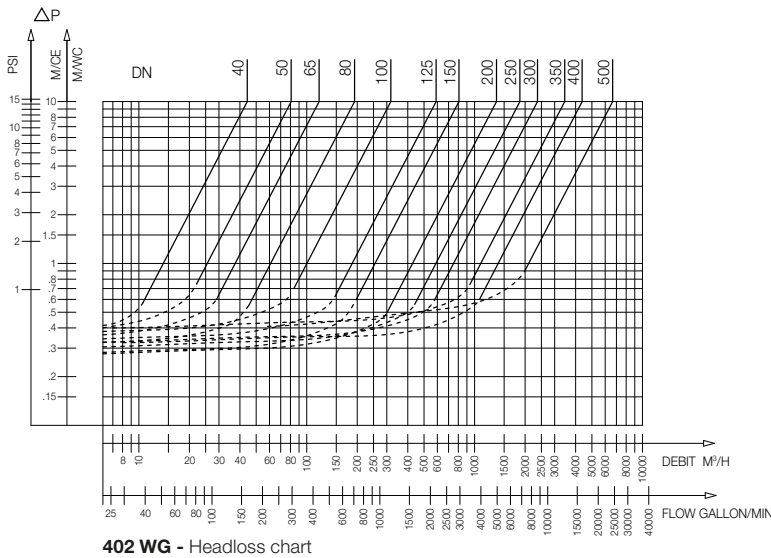

DN mm	Opening pressure in mm/CE			Without spring	Kv m³/H	ζ
	↑	↓	↔			
40	440	210	320	120	44,2	2,10
50	440	220	330	110	80,8	1,50
65	450	190	320	130	118,5	2,00
80	450	190	320	130	192,8	1,80
100	500	240	370	130	318,0	1,60
125	510	210	360	150	590,0	1,10
150	550	210	380	170	807,5	1,25
200	590	210	400	190	1351,0	1,40
250	710	210	460	250	1861,8	1,80
300	820	90	460	365	2371,7	2,30
350	860	100	480	380	3444,7	2,00
400	800	50	410	390	4371,2	2,14
500	1030	0	430	580	6646,2	2,26

# Sizing

A	B	C	D
mm	mm	mm	mm
40	85	80	150
50	100	97	165
60	120	125	185
80	140	150	200
100	170	187	220
125	200	220	250
150	230	250	285
200	289	340	340
250	354	420	405
300	396	490	460
350	473	586	533
400	560	680	597
500	750	880	670

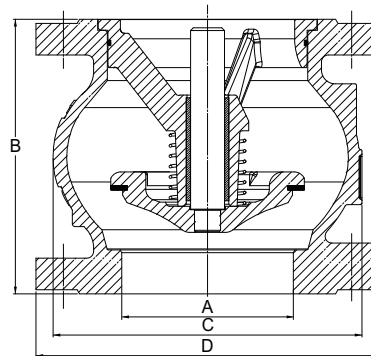

# Other technical information

## Dynamic closing characteristics:

An overpressure of 5 bar is measured at the backing non-return valve 402 in DN 150 mm when the pump stops, for a initial flow of 150m³/h under 5 bar (according to the tests realized by the CETIM).

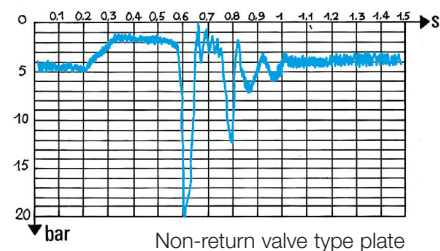
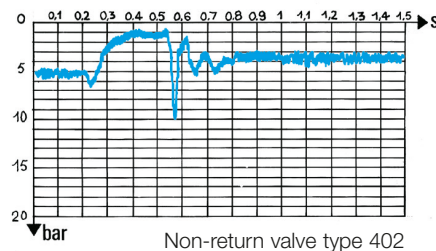

The descriptions and photographs contained in this product specification sheet are supplied by way of information only and are not binding.

Socla reserves the right to carry out any technical and design improvements to its products without prior notice. Warranty : All sales and contracts for sale are expressly conditioned on the buyer's assent to Socla terms and conditions found on its website at [www.socla.com](http://www.socla.com). Socla hereby objects to any term, different from or additional to Socla terms, contained in any buyer communication in any form, unless agreed to in a writing signed by an officer of Socla.



**A WATTS Brand**

**Socla sas**

365 rue du Lieutenant Putier • 71530 Virey-Le-Grand • France  
 Tel. +33 03 85 97 42 00 • Fax +33 03 85 97 42 42  
 contact@wattswater.com • www.socla.com  
 ISO 9001 version 2015 / ISO 18001